

# PH/ORP Online Analyzer

## Operation Manual







## Introduction

- Thank you for purchasing the PH/ORP online analyzer. The operation manual gives a detailed description about various realizable functions, wiring methods, setup methods, operation methods and fault handling methods. Please read carefully the operation manual and understand the correct application methods before putting into operation, to avoid unnecessary losses due to operation mistakes. If the instrument is operated in other ways not described in the manual, the protections that the instrument give may be destroyed, and the failures and accidents incurred due to violation of precautions shall not be borne by our company.
- Please read the operation manual carefully before applying the instrument. On the precondition of full understanding, the instrument shall be installed, operated and maintained by professional electrical personnel at site. Wrong installation or operation may lead to destruction of instrument or personal injury.
- The company promises to the user that, the hardware and accessories provided with the instrument during delivery shall not have any defects in materials and manufacturing process. Calculated from the day of purchase of the instrument, if the user informs of any defect on the product in the guaranty period, the company provides free maintenance or replacement unconditionally for the defect product. The company guarantees to provide lifelong maintenance for all the products.
- Following the principle of sustainable development, the company shall reserve the rights of modifying the performance parameters in the operation manual and also the rights of amending or abolishing the operation manual, without prior notification. The company shall notify the user in advance if modification of some parameters of the instrument may lead to serious accident. For improved instrument, the company shall publish updated operation manual or improvement instruction. If the descriptions in the operation manual deviate from the material object, the latter shall prevail.

- Any modification on the instrument is forbidden. Any accidents incurred due to unauthorized modification shall not be borne by the company.

## Indication of Signs in the Operation Manual

Sign	Name	Meaning
	DANGER	Serious personal injury, instrument destruction, great property losses or other accidents will be the consequence if no appropriate preventive measures have been adopted.
	ALERT	Pay special attention to the important information linked to product or particular part in the operation manual.
	WARNING	Operate with cautious. Any operation mistake may lead to big problems.
	ATTENTION	Read carefully the annotation, which will provide substantial help to correct operation of the instrument.



### DANGER

- Do not use the instrument in a flammable and combustible or steam area.
- The instrument can work in general cases. If the failure of the instrument may result in major accident or destroy other equipment, emergency stop electric circuit and protection loop should be set up.
- Confirm if the supply voltage is in consistent with the rated voltage before operation.
- To prevent from electric shock, operation mistake, abnormal display or big deviation in measurement, a good grounding protection must be made.
- Thunder prevention engineering facilities must be well managed: the shared grounding network shall be grounded at is-electric level, shielded, wires shall be located rationally, SPD surge protector shall be applied properly.
- Some inner parts may carry high voltage. Do not open the square panel in the front except our company personnel or maintenance personnel acknowledged by our company, to avoid electric shock.
- Cut off electric powers before making any checks, to avoid electric shock.

- Check terminal screws and installation conditions on a regular basis. If it's loose, tighten it and then apply it.
- Unauthorized dismantling, processing, modification or repair of instrument can never be allowed. Otherwise, the instrument may move abnormally, or electric shock or fire accidents may be caused.
- Use dry cotton to wipe the instrument, instead of alcohol, gasoline or other organic solvent. Prevent any liquid from splashing onto the instrument. If the instrument falls into water, cut off power immediately, to avoid electric leakage, electric shock and fire accidents.
- Check grounding protection and fuse conditions on a regular basis. Do not run the equipment if grounding protection and fuse are not well equipped.
- The ventilation hole on the instrument casing must be kept unclogged, to avoid failure, abnormal movement, short lifetime and fire accident due to high temperature.
- Operate in strict accordance with the operation manual, otherwise, it's possible to damage the protection device of the instrument.

**ALERT**

- Do not use the instrument if it is found damaged or deformed at opening of package.
- Prevent dust, wire end, iron fines or other objects from entering the instrument during installation, otherwise, it will cause abnormal movement or failure.
- During operation, to modify configuration, signal output, startup, stop, operation safety shall be fully considered. Operation mistakes may lead to failure and even destruction of the instrument and controlled equipment.
- Each part of the instrument has a certain lifetime, which must be maintained and repaired on a regular basis for long-time use.
- The product shall be scrapped as industrial wastes, to prevent environment pollution.

## **User instruction**

Please respect the operation procedures and precautions in the operation manual to use the product.

The instrument can work in general cases. If the failure of the instrument may result in major accident or destroy other equipment, emergency stop electric circuit and protection loop should be set up.

- The quality guaranty period of electrode of conductivity is one year, for the sake of more accurate measurement. After one year upon ex-work, the performance

will be influenced whether to be further used. Then it should be replaced in time.

- Power on the instrument before calibration to preheat for over half an hour.
- During measurement, clean the instrument in distilled water (or deionized water) and dry with filter paper, to avoid inclusions in the test liquid.
- Contact the manufacturer in case of anomaly or damage of the instrument. Do not repair it at your own.

## Contents

Introduction.....	1
Indication of Signs in the Operation Manual.....	2
User Instruction.....	3
Contents.....	5
Section I Product Introduction.....	6
Characteristics.....	6
Technical Indicators.....	7
Section II Fixation & Installation.....	8
Installation of Instrument.....	8
Installation of Electrode.....	9
Wiring of Instrument.....	10
Section III Push-button Operation.....	12
Section IV HMI and Operation.....	13
Section V Setting.....	15
System Setting.....	15
Signal Setting.....	15
Online Calibration.....	16
Remote Setting.....	17
Alarm Setting.....	17
Information Inquiry.....	18
Section VI Communication.....	19
Section VII Product Maintenance.....	21
Section VIII Failure Analysis & Trouble-shooting.....	23

## Section I Production Introduction

Independent research and development of electronic online monitoring PH / ORP value, through the RS485 or current transmission remote access to the monitoring room for record and save.

PH / ORP tester is one of the intelligent online chemical analysis equipment, is a widely used in thermal power, chemical fertilizer, metallurgy, environmental protection, Pharmaceutical, biochemical, food and tap water solution PH value or ORP value and temperature of the continuous monitor.

Continuous monitoring data through the transmission output connection recorder to achieve remote monitoring and recording, you can also connect the RS485 interface through the MODBUS-RTU protocol can be easily connected to the computer to achieve monitoring and recording.

### Characteristics

- Design of board card modularity, for convenience of assembly and configuration.
- 2.4 inches 12864 lattice screen.
- Isolating transmitting output, with little interference.
- Isolating RS485 communication.
- Can be PH / ORP measurement, temperature measurement, upper and lower limit control, transmission output, RS485 communication.
- Configurable manual and auto temperature offset function.
- Configurable upper/lower limit warning and delay.
- Configurable hummer and LCD backlight switch.
- Addition of universal password.
- Industrial controlled door keep, to avoid instrument halted.

## Technical indicators

- Can be set to isolate the transmission 4-20 mA output, the maximum loop 750  $\Omega$ , 0.1% FS
- Measuring range: PH (0-14 PH); ORP (-1000- + 1000 mV (customization: -2000- + 2000 mV))
- Accuracy:  $\pm 0.02$  PH;  $\pm 1$  mV
- Resolution:  $\pm 0.01$  PH;  $\pm 1$  mV
- stability:  $\leq 0.02$  PH / 24H;  $\leq 3$  mV / 24H
- Input impedance:  $\geq 10^{12}$   $\Omega$
- Temperature measurement range: -10-130  $^{\circ}\text{C}$  , accuracy:  $\pm 0.5$   $^{\circ}\text{C}$  (NTC10K or PT1000)
- Temperature compensation: -10-130  $^{\circ}\text{C}$  Manual / automatic
- RS485 function: compatible with the standard MODBUS-RTU communication protocol
- Power supply: AC220V  $\pm 10\%$ , 50Hz / 60Hz (customization: AC110V  $\pm 10\%$ , 50Hz / 60Hz or DC 24V)
- relay alarm: two normally open normally closed alarm relay AC250V, 3A
- Language: Chinese and English can be switched



## Section II Fixation & Installation

### Installation of instrument



Please read the instruction of installation location and method of instrument as described during installation.

### Installation precautions



The instrument serves mainly for detection and transmission, not dedicated for control. It is equipped with a relay switch output, for warning and reminding use generally. If the user involves the function in participating loop control, the failure of the instrument may lead to major accident or destruction of other equipment, emergency stop electric circuit and protection loop should be set up. Otherwise, the company will not be liable for any consequences incurred.

The instrument is panel-mounted and should be installed indoor, sheltered from wind, rain and direct sunlight. To avoid rise of temperature inside the instrument, it should be installed at a well-ventilated place. Do not tilt it during installation and try to locate it horizontally (tilting back <math><30^\circ</math>).

### Installation should be kept away from the following site

In direct exposure to sunlight and near thermal equipment.

With ambient temperature over 60 degrees in operation.

With humidity over 85% in operation.

Nearby electromagnetic source.

In strong mechanical vibration.

With varying temperature and dew condensation.

With oil smoke, steam, humidity, dust and corrosive gases.

## Installation methods

Install a 92.5 \* 92.5 mounting hole on the instrument cabinet or mounting panel

The instrument into the mounting hole and then buckle on the butterfly, as shown below

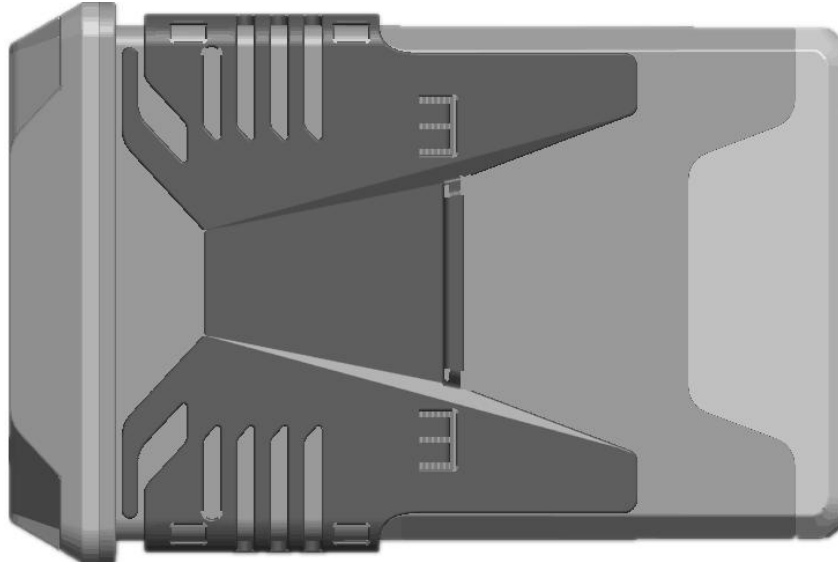

## Installation of electrode

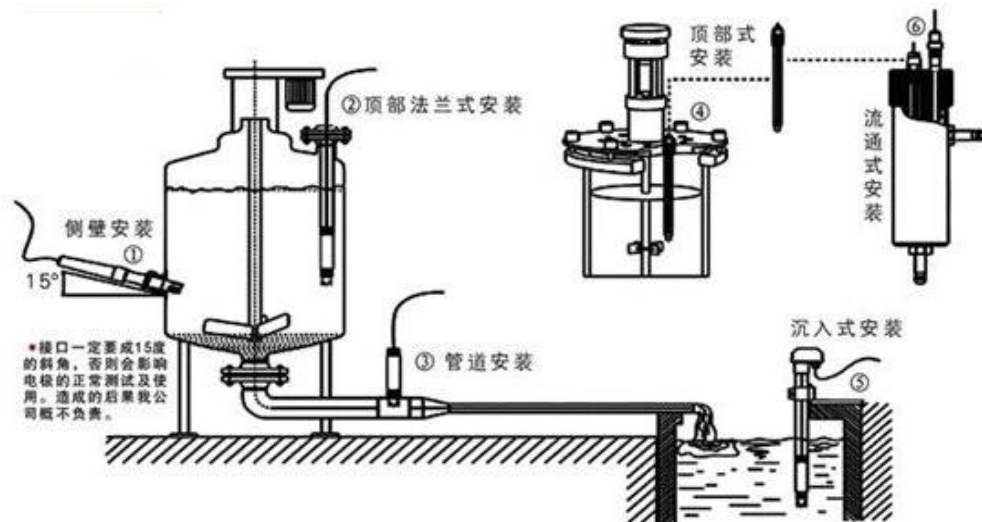

Schematic diagram of common installation method

- ①Side wall installation    ②Flange mounted at the top    ③Pipe installation    ④Top installation    ⑤Submersible installation    ⑥Flow-through installation

The interface must be in 15° oblique angle, or it will affect the normal test and use of the electrode. We won't be responsible for any results due to this.

## Instrument wiring

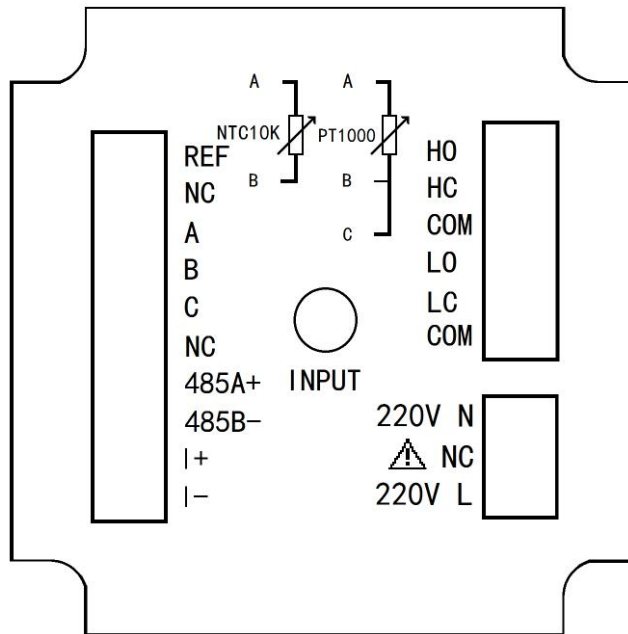

Wiring diagram

### Identification of terminal

- INPUT: Measuring terminal of the electrode
- REF: Reference terminal of the electrode
- NC: Unidentified
- A: Temperature compensation terminal A, NTC10K and PT1000 connect here
- B: Temperature compensation terminal B, NTC10K and PT1000 connect here
- C: Temperature compensation terminal C, PT1000 three-wire temperature grounding, PT1000 two-wire need to be short-connected to TEMPB, not NTC10K.
- NC: Unidentified

- RS485 (A +): RS485 communication interface A +
- RS485 (B -): RS485 communication interface B-
- 4-20mA (+): 4-20mA output end+
- 4-20mA (-): 4-20mA output end-
- AC220V (L): AC220V FireWire
- AC220V (N): AC220V zero line
- HO: high alarm normally open relay
- HC: high alarm normally closed relay
- LO: low alarm normally open relay
- LC: low alarm normally closed relay
- COM: common

## Notes

Confirm that the instrument is not power on before connected with signal wire, to avoid electric shock.

Use double insulation wire to prevent fire accident.

Do not put electric product close to signal terminal, which may cause failure.





The instrument is able to switch conductivity measuring range. In between, 6 seconds of delayed alarm is left as margin, to protect against anomaly of warning.

## Section III Push-button Operation

### Button display



### Definition of buttons

Sign	Button Name	Function description
	EXIT	Check related warning status on the “monitoring page” Return to previous level page in the up& down level page linked to “menu page”
	MOVE RIGHT	Make a recurrent selection of digit of parameters Remove the original indication value in the “conductivity calibration page”
	MENU	Enter the MENU on the “monitoring page” Exit the MENU on the “menu page”
	MOVE DOWN	Select the related menu on the “menu page” Modify the values in the configuration state
	ENTER	Enter the sub-menu or confirm modification on the “menu page”

## Section IV HMI and Operation

### Monitoring page

The instrument is equipped with monochrome lattice LCD, 128\*64 resolution.

Push [MENU] to enter password verification page; input password to enter the home page.

Push [EXIT] to enter alarm inquiry page, to inquire the current warning configuration information.

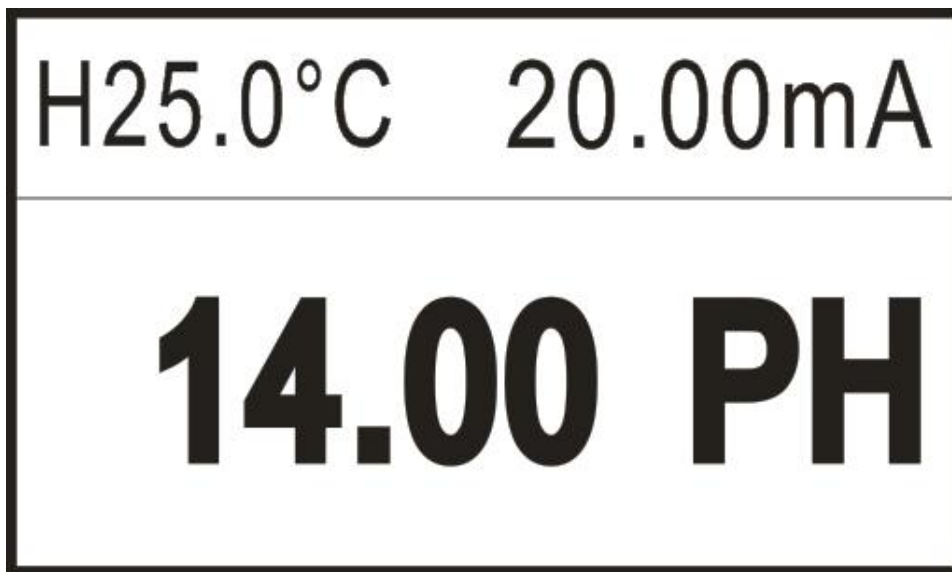

PH monitoring page

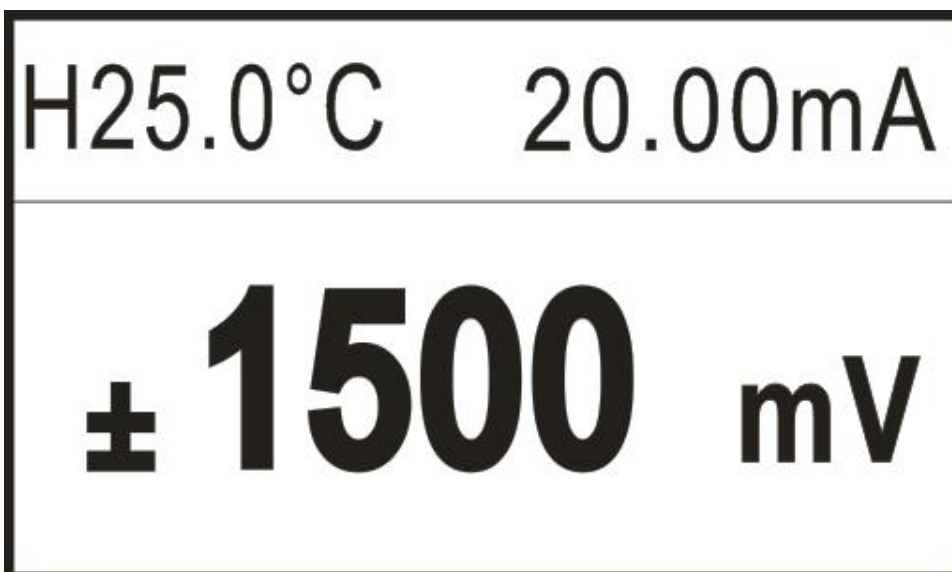

ORP monitoring page

## Password verification page

Input password and push [CONFIRM] to enter home page.

Initial password is 0000, which can be modified via password modification function.

Please contact us if you forget your password.

----- User Password -----

Password: 0000

## Main Menu

----- Main Menu -----

- ➡ 1. System Setting
- 2. Signal Setting
- 3. Online Calibration
- 4. Remote Setting
- 5. Alarm Setting
- 6. Information Inquiry

System Setting: settings of language, buzzer and backlight, modification of password and factory settings

Signal Setting: Toggle electrode type and automatic/manual temperature compensation.

Online Calibration: Calibrate or correct PH and ORP signal.

Remote Setting: settings of RS485 parameters and current transmission output.

Alarm Setting: settings of parameters of high and low warning.

Information Inquiry: current version number.

## Section V Setting

### System Setting

#### ----- System Setting -----

- ➡ 1. Language
- 2. Buzzer
- 3. Backlight
- 4. Change Password
- 5. Factory Setting

Language: language type, Chinese or English.

Buzzer: settings of switch of buzzer during warning.

Backlight setting: settings of LCD backlight.

Password modification: password modification and log-in with new password.

Factory setting: return to factory settings

### Signal Setting

#### ----- Signal Setting -----

- ➡ 1. Electrode Type
- 2. Temp Compensation

Electrode type: set the electrode type, PH electrode and ORP electrode two types.

Temperature compensation: set the automatic warming or manual temperature compensation, the temperature range of -10-130 °C. Temp Switch: auto temperature offset NTC10K or PT1000 or manual temperature compensation, temperature range: -10°C-130.0°C.



## Online calibration

- — — — Online Calibrtion — — — —
- ➡ 1.PH Calibration
  - 2.PH Modification
  - 3. ORP Calibration
  - 4. ORP Modification

PH Calibration: Enter the PH calibration screen, the first PH electrode into the 4.00PH standard solution, standing for a moment, to be stable after the show, press the **【 ENT 】** , then the PH electrode into the 6.86PH standard solution Set the PH electrode into the 9.18PH standard solution, put it aside for a moment, after the test is stable, press **【 ENT 】** , the display shows the success of the calibration, the whole process of PH calibration completes.

PH Modification: The measured PH can be modified between 2 PH values.

ORP Calibration: enter the ORP calibration screen, the first ORP electrode into the 86mV standard solution, standing for a moment, to be shown after the stability, press the **【ENT】** , then the ORP electrode into the 256mV standard solution, static Set a moment, after the display is stable, press the**【ENT】**display calibration is successful, ORP calibration process is over.

ORP Modification: The measured ORP can be modified between 300mV.

Temperature correction: You can correct the temperature of the automatic temperature compensation, the correction range is  $\pm 20.0$  °C.

## Remote Transmission Setting

- Remote Setting -----
- ➡ 1. RS485
  - 2. Current Transmission

RS485 setting: settings of 485 communication address and baud rate.

Current transmission: settings of 4mA corresponding value and 20mA corresponding value of 4-20mA output.

## Alarm Setting

- Alarm Setting -----
- ➡ 1. PH High Alarm
  - 2. PH Low Alarm
  - 3. ORP High Alarm
  - 4. ORP Low Alarm

PH High Alarm: when the measured value is greater than the high reported pull value, the high reported relay pull, when the measured value is less than the high reported off value, the high news relay disconnect.

PH Low Alarm: when the measured value is less than the low pull-in value, the lower newspaper relay pull, when the measured value is greater than the low reported off value, the low alarm relay off.

ORP High Alarm: when the measured value is greater than the high reported pull value, the high reported relay pull, when the measured value is less than the high reported off value, the high reported relay disconnect.

ORP Low Alarm: When the measured value is less than the low pull-in value, the low relay relays, when the measured value is greater than the low reported off value, the low alarm relay off.

## Information inquiry

### ----- Information Inquiry ----- ➡ 1. Version Information

Information inquiry: inquire the current hard software version, high traceability.

## Section VI Communication

The instrument is provided with standard RS485 series communication interface, in accordance with international universal standard MODBUS-RTU communication protocol, supporting No.03 register reading and holding command.

### MODBUS standard format (No.03 register reading and holding command)

#### Command format:

Definition	Address	Function code	Register address	Number of data	CRC check
Data	ADDR	0x03	M	N	CRC 16
Number of bytes	1	1	2	2	2

#### Return format:

Definition	Address	Function code	Data size	Data	CRC check
Data	ADDR	0x 03	2*N	Data	CRC 16
Number of bytes	1	1	1	2*N	2

#### Register address description:

Address	Data type	Date size	Function code	Description	Access authority
0x0000	unsigned long	4 bytes	0x03	PH value (default two decimal places)	Read only
0x0002	short	2 bytes	0x03	Temperature (default 1 decimal)	Read only
0x0003	unsigned long	4 bytes	0x03	ORP value (signed integer)	Read only

**Communication case:**

The computer sends: 00 03 00 00 00 01 85 DB

PH / ORP Table Returns: 00 03 02 02 AE 05 58

Return command comment: 00 is 485 address;

03 is the function code;

02 is the data length of the return PH value: 2 bytes;

02 for the return of the PH value of 686 (hex high byte);

AE for the return of the PH value of 686 (hex low byte);

05 58 is the CRC check value;

**Example of temperature reading:**

Computer sends: 00 03 00 02 00 01 24 1B

Conductivity meter returns: 00 03 02 00 FA 05 C7

Return command annotation: 00 is the address of slave, which can be configured in the instrument;

03 is function code, reading and holding register;

02 is the length of data of returned temperature value, 2 bytes;

00 FA is the returned temperature value, 25.0°C,

unit: °C. The value obtained shall be divided by 10 to get the current temperature value. The range:

-10.0-130.0°C.

05 C7 is the CRC16 check code, which is varying depending on different data;

## Section VII Product Maintenance

1. The storage of PH glass electrode, short-term: stored in the PH = 4 buffer solution; long-term: stored in the PH = 7 buffer solution.

2. PH glass electrode cleaning glass electrode bulb contamination may make the electrode response time longer. CCl<sub>4</sub> or soap can be used to wipe the dirt, and then immersed in distilled water a day and night to continue to use. When the pollution is serious, can be 5% HF solution for 10 to 20 minutes, immediately rinse with water, and then immersed in 0.1N HCl solution for a day and night to continue to use.

3. Glass electrode aging treatment: the aging of the glass electrode and the gradual change in the structure of the glue layer. Old electrode response is slow, film resistance is high, slope is low. Exfoliation of the outer layer with hydrofluoric acid can often improve electrode performance. If this method can be used to regularly remove the inner and outer layers, the electrode life is almost unlimited.

4. The storage of the reference electrode Silver - silver chloride electrode The best storage solution is saturated potassium chloride solution, high concentration of potassium chloride solution can prevent the silver chloride in the liquid junction precipitation, and maintain the liquid junction in the work status. This method also applies to the storage of composite electrodes.

5. The reference electrode regeneration reference electrode problems caused by the vast majority of liquid junction caused by blockage, the following methods can be resolved:

(1) Soaking fluid interface: 10% saturated potassium chloride solution and 90% distilled water mixture, heated to 60 ~ 70 °C, the electrode immersed in about 5cm, soak for 20 minutes to 1 hour. This method dissolves the crystallization of the electrode tip.

(2) Ammonia Soaking: When the liquid interface is blocked by silver chloride can be leaching with concentrated ammonia. The specific method is to clean the electrode, the liquid vent after immersion in ammonia 10 to 20 minutes, but do not let ammonia into the electrode inside. Remove the electrode with distilled water to wash, re-add

the internal liquid and continue to use.

(3) Vacuum method: the hose to match the reference electrode fluid interface, the use of water suction pump, suction part of the liquid through the fluid interface, remove the mechanical blockage.

(4) Boiling fluid junction: silver - silver chloride reference electrode liquid interface immersed in boiling water for 10 to 20 seconds. Note that the next time you boil, the electrode should be cooled to room temperature.

(5) When the above methods are invalid, sandpaper grinding can be used to remove the mechanical method of grinding. This method may cause the sand under the grinding into the liquid interface. Causing permanent clogging.

## Section VIII Failure Analysis & Trouble-shooting

1. No display on controller?

A: Check if the power cable is correctly connected, power is on.

2. Number in display is jumping up and down?

A: Check if there is any interference equipment such as frequency converter is nearby. The instrument should be kept away from such interference equipment or protected with good shielding measures.

3. Conductivity instrument can not be calibrated?

A: The standard solution is not mixed in a correct way or the electrode is damaged.

4. The instrument can not measure accurately after calibration with a standard solution of conductivity of 1413us/cm?

A: Check if the standard solution is polluted. Replace the solution and calibrate again.

5. The response of number is slow?

A: If the electrode is covered by dirt, the response would be slow. Clean the pollutant in a corresponding method. A slow response is normal in winter.